

Medizintechnik und Implantologie

Medical Technology and Implantology

micro-tooling
 $\phi > 0,33 \text{ mm}$





HÜFTENDOPROTHESE

Kunstpfanne aus Polyethylen

HIP SOCKET

artificial cup out of polyethylene

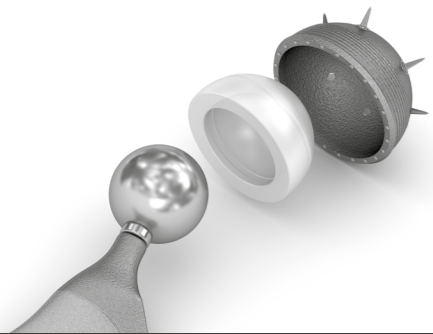

10. SXJ

Stirn-Kopierstahl
front copying cutter

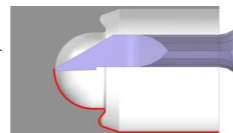

- höchste Genauigkeit im System
- schneidend bis ins Zentrum
- problemlose Abbildung von Kugelformen
- sehr glatte Werkstückoberfläche
- ultra high accuracy
- cutting to the core
- easy reproduction of spherical shapes
- very smooth surface of the machined part

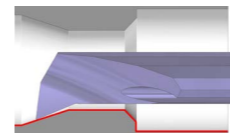

1. SDH

Hinterdrehstahl
back-off cutter



- höchste Genauigkeit im System
- Hinterdrehen und Hinterstechen im Bohrloch
- spiralgenutet zur besseren Spanbildung
- ultra high accuracy
- back-off cutting and producing undercuts in the borehole
- spiral fluted for better chip formation

DORSALE STABILISIERUNG

Pedikelschraube

DORSAL STABILISATION

pedicle screw

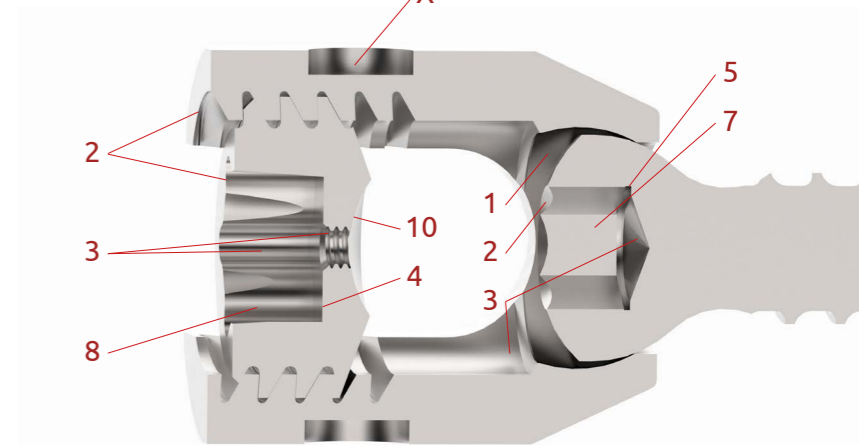
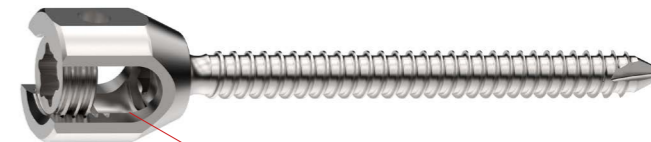

X = Spezialwerkzeug | custom tool

DENTALIMPLANTAT
Innenkontur Zahnimplantat
DENTAL IMPLANT
inner shape of a dental implant

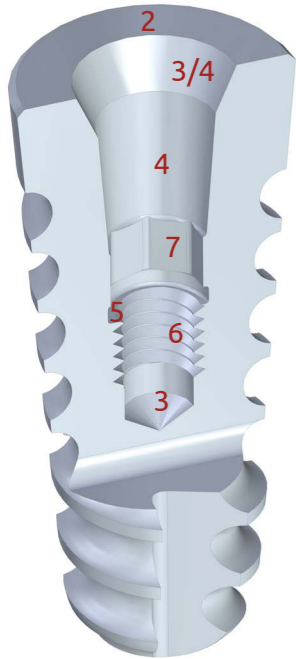
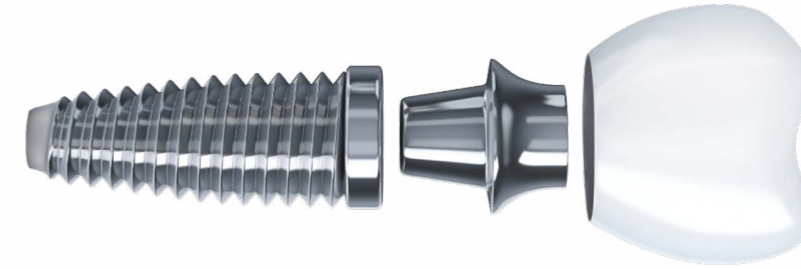

2. DRP

Punktanbohrer
centering pointer

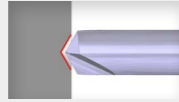

3. DRA

Anfasbohrer
chamfering drill



4. SDG

Bohrstange
boring bar

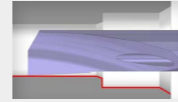

5. SDS

Innen-Einsteckstahl
internal grooving
cutter

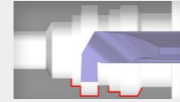

6A. SDU

Gewindedrehstahl
threading cutter

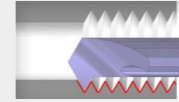

6B. WHN

Gewindewirbler
thread whirler

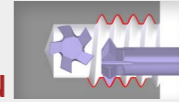

7. BRH
8. BRT

Stoßwerkzeug
broaching tool

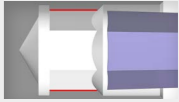

ENDOSKOPIE
Rohr- und Linsensitz
ENDOSCOPY
tube- and lense fitting

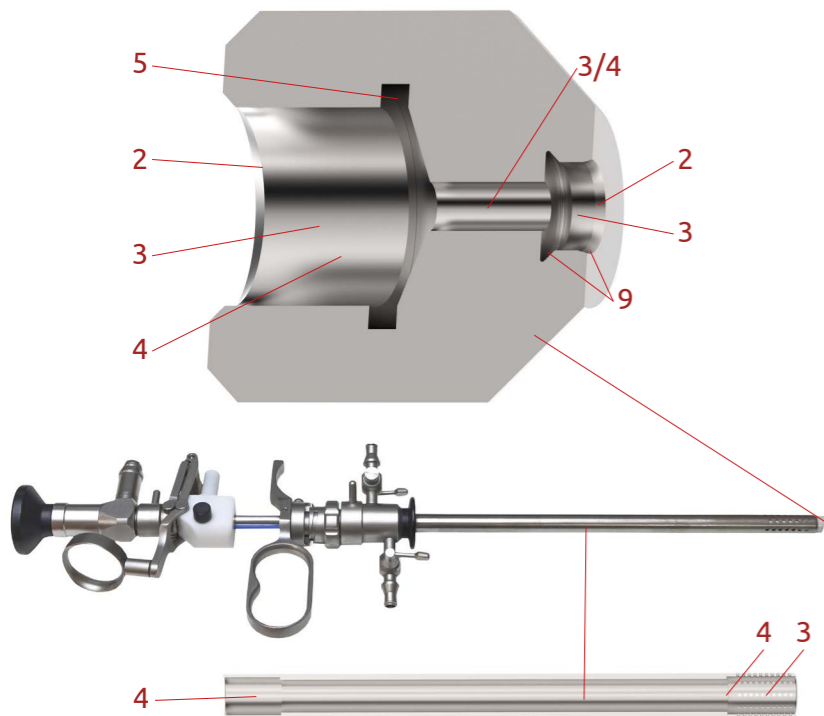

9. SDW

Auskammerstahl
chambering tool

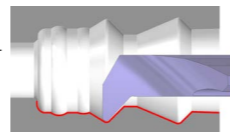

- höchste Genauigkeit im System
- Auskammern und Anfasen in Einem
- spiralgenutet zur besseren Spanbildung
- nach hinten 47° frei zur Erstellung von Fasen
- ultra high accuracy
- chambering and chamfering within one tool
- spiral fluted for better chip formation
- backwards chamfer due to 47° angle

4. SDG

Bohrstange
boring bar

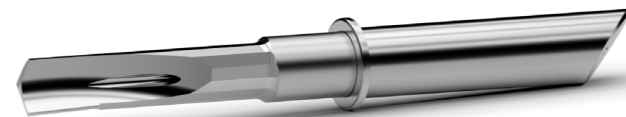
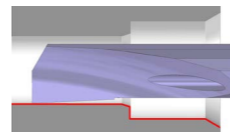

- höchste Genauigkeit im System
- bohrerähnlich
- spiralgenutet zur besseren Spanbildung
- extreme Schärfe
- polierte Spanflächen und kleine Eckradien
- ultra high accuracy
- drill-like
- spiral fluted for better chip formation
- extraordinary sharpness
- polished chip flutes and small edge radius

HERZSCHRITTMACHER
Elektroden Komponente

PACEMAKER
component of the electrodes

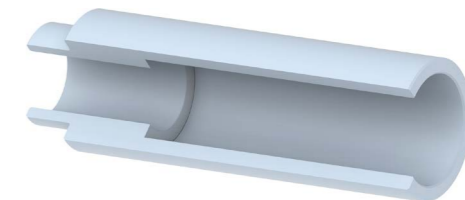

HOBE

micro
tools

Humanmedizinische Instrumente, Implantate und Prothesen müssen höchste Qualitätsansprüche erfüllen. Nur so können gesundheitliche Risiken abgewendet und eine lange Produktlebensdauer erreicht werden. Das Hobe micro tools Sortiment hält eine große Auswahl an VHM-Hochleistungswerkzeugen bereit, die für die Produktion medizinischer Hilfsmittel bestens geeignet sind.

Schwer zerspanbare Materialien (z.B. Platin, Titan, u.a.) stellen uns bei der Werkzeugentwicklung vor besondere Herausforderungen – die wir mit Freude annehmen. Durch intensiven Austausch mit unseren Kunden verfügen wir über fundiertes Prozesswissen in den Bereichen Implantatprothetik und Dentaltechnik.

Unsere Expertise bei der Zerspanung führt zu überzeugenden Ergebnissen hinsichtlich Oberflächengüte und Passgenauigkeit.

Human medical instruments, implants and prostheses require the highest quality standards. This is the only way to avoid health risks and achieve a long product life. The Hobe micro tools range includes a wide range of VHM high performance tools that are ideal for medical device production.

Hard-to-machine materials (e.g. platinum, titanium and others) present us with special challenges in tool development - which we gladly accept.

Through intensive exchange with our customers, we have in-depth process knowledge in the field of implant prosthetics and dental technology.

Our expertise in machining leads to convincing results in terms of surface quality and accuracy of fit.

Hobe GmbH | micro tools
Baindter Straße 27
88255 Baienfurt
Germany

 +49 (0)751 56092 0

 +49 (0)751 56092 18

 info@hobe-tools.de

 www.hobe-tools.de