

SPEEDIO

S300Xd2	R450Xd1	U500Xd2
S500Xd2	R650Xd1	H550Xd1
S700Xd2	M200Xd1	DG-1
W1000Xd2	M300Xd1	

Cutting Out the Waste

Times are changing. Are you ready?
 You need a machine that's fast and compact.
 With the ability to make any cut.
 In this world, only the strong survive.
 Make it better with SPEEDIO.

SPEEDIO

Extensive lineup further expands the potential of BT30 spindle machines, and provides customers with the best waste-free solution

* Simultaneous 5-axis specifications can be selected for models where [5AX available] is indicated.

S

Compact Machining Center

S300Xd2



[5AX available]

S500Xd2



[5AX available]

S700Xd2



[5AX available]

W

Wide Travel Compact Machining Center

W1000Xd2



U

Universal Compact Machining Center

U500Xd2



[5AX available]

R

Pallet Changing Compact Machining Center

R450Xd1



R650Xd1



H

Horizontal Compact Machining Center

H550Xd1



Special Options

Rotary Table
T-200Ad



Loading System
BV7-870Ad



M

Compact Multi-Tasking Machine

M200Xd1



[5AX available]

M300Xd1



[5AX available]

Deburring Center
DG-1



SPEEDIO

Blue Technology

There are many types of waste in cutting processes.

Our original NC control (machine/controller integrated development)

makes operation at work sites easier,

drives machine performance to the fullest, and

eliminates all possible waste through optimized control.

Non-cutting time leads to wasted time.

Producing defective products leads to wasted resources.

Consuming electricity or air during stoppage of machines leads to wasted energy.

Equipment that is larger than necessary leads to wasted installation space.

SPEEDIO eliminates all these waste elements and contributes to your profitability and reduction in global environmental impact.



Wasted time reduction



Wasted resource reduction



Wasted energy reduction



Wasted installation space reduction

SPEEDIO Blue Technology

Solves Four Waste Elements at Production Sites

Eliminating waste elements at production sites leads to reduction in greenhouse gas emissions, such as carbon dioxide and methane.

Brother's optimal and compact design reduces wasted time, resources, and energy during parts machining.

We are striving to reduce environmental impact by conducting product life cycle assessment, which quantitatively evaluates environmental impact at each stage of production, transportation, use, disposal, and recycling.

Wasted time reduction



Wasted time is reduced by minimizing non-cutting time in the machining cycle time and reducing setup time and downtime.

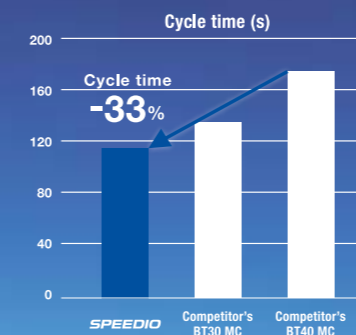

Wasted resource reduction



Wasted resources are reduced by using machining adjustment support that prevents cutting defects and production support such as real-time monitoring.



Wasted energy reduction



Optimal design eliminates all waste, including excessive power consumption and air flowrate, achieving industry-leading energy-saving performance.

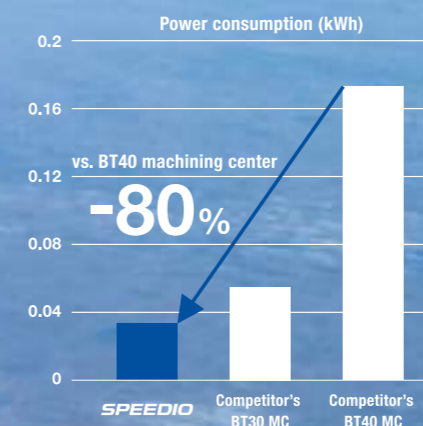

Wasted installation space reduction



Compact design reduces wasted space with less restrictions on installation locations.



*1. Dimension including coolant tank
*2. Compared to BT40 horizontal MC with equivalent travels



Wasted Time Reduction

The lightweight and low-inertia features of BT30 machines and our original NC drives machine performance to the fullest. All possible wasted time is reduced by shortening machining cycle time, improving efficiency of setup work, and supporting recovery from downtime.

Reduction in cycle time

Cycle time is reduced significantly by non-stop ATC for high-speed tool change, high acceleration/deceleration spindle for faster spindle start/stop, and simultaneous operation for eliminating wasted time.

Non-stop ATC



Simultaneous operation



High acc/dec spindle



Reduction in setup time / downtime



ATC tool app

You can easily perform magazine tool registration, tool data editing, and magazine tool removal/attachment operation on one screen.



Recovery support app

Recovery work instructions are displayed to reduce machine downtime.



Wasted Energy Reduction

Equipped with various energy-saving functions, including a power regeneration system. Air consumption optimized by eliminating any unnecessary functions reduces wasted energy.

Saving power

Highly efficient spindle motor provides fast response to rotation and stop, achieving highly efficient cutting with less power. Equipped with a power regeneration system that recycles energy generated when a servo motor decelerates.

Highly efficient spindle motor



Power regeneration system

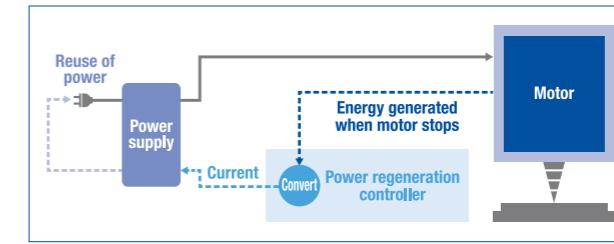

Energy-saving NC functions

- Standby mode** Turns the servomotor off when the machine is not operated for the preset time.
- Automatic work light off** Turns the work light off when the preset time elapses.
- Automatic power off** Turns the NC power off at the preset time.
- Automatic display off** Turns the backlight of the screen off when the screen is not operated for the preset time.
- Automatic coolant off** Turns the coolant pump off when the preset time elapses.

Saving air

Air related functions have been reviewed and optimized to eliminate any waste, leading to reduction in air consumption.

Air purge

Flowrate analysis achieves a highly airtight structure that prevents coolant from entering the spindle, significantly reducing the amount of air used.

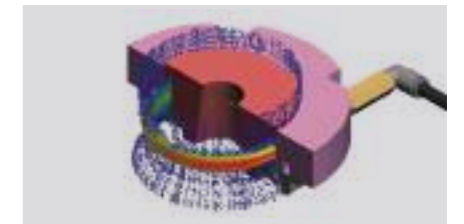

Spindle air blow

Cleaning power has been enhanced by discharging three times the conventional volume of air only when required, while halving the total amount of air used.



Wasted Resource Reduction

Wasted resources are reduced by achieving high reliability through maintenance functions that prevent machining defects, failures, and possible operational mistakes in daily production sites.

Defect reduction / Preventive maintenance



Stuck chips detection function

Chips caught between the spindle and the holder during ATC are detected without using a sensor.



Machining parameter adjustment app

You can easily set the optimal acceleration or adjust the balance of machining accuracy and surface quality.



ATC tool monitoring

Checks the presence of a spindle tool without using a sensor.



Effective use of resources

Automatic grease lubricator that optimizes consumption



Tank with cyclone filter and no consumables

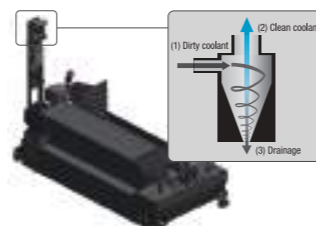

Wasted Installation Space Reduction

Compact design reduces wasted space with less restrictions on installation locations.

Compact design

Compact design allows machines to be installed efficiently even in limited space. When building a new factory, the floor space can be reduced, which requires less lighting and air conditioning, leading to factory-wide energy saving.

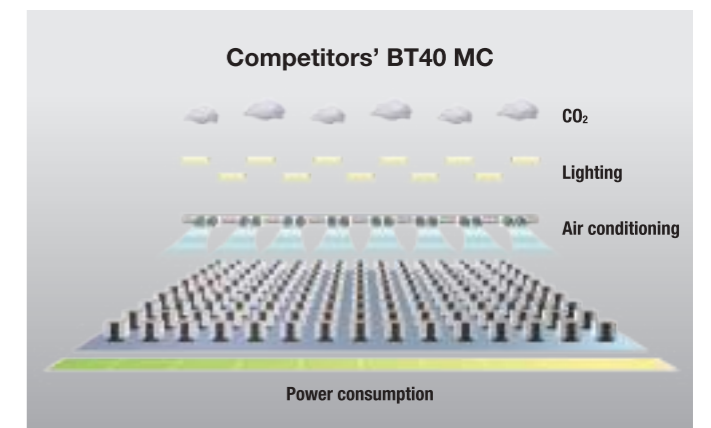
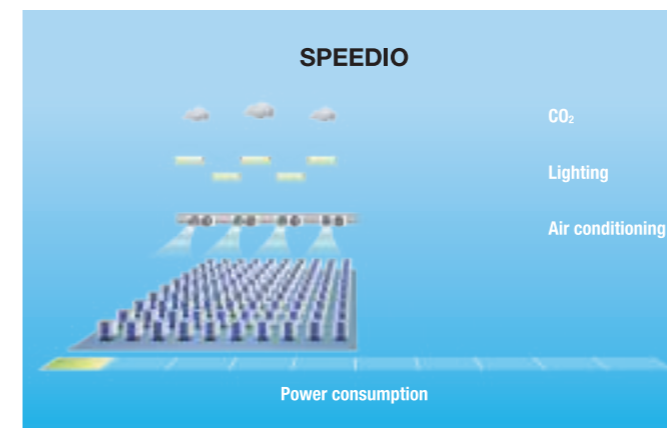

A wide range of SPEEDIO series is available to meet customers' purposes, such as best-selling model, wide travel model, pallet changing model, multi-tasking model, and horizontal model. With an extensive lineup that further expands the possibilities of BT30 machines, we provide customers with optimum waste-free solutions.

S

High performance model suitable for a broad range of machining applications
Extensive spindle specifications and machine sizes
 Further pursuing high productivity and high reliability



S300Xd2

S500Xd2

S700Xd2

Increased Y-axis travel

Increased Y-axis travel expands the range of target workpieces.

Y-axis travel **400mm^{*1}** ▶ **450mm**

Bigger table

Bigger table expands the range of jig selection.

S300/S500Xd2 **600 x 400^{*1}** ▶ **600 x 450mm**
 S700Xd2 **800 x 400^{*1}** ▶ **800 x 450mm**



*1. Values of previous model

Z-axis 380 mm spec. (optional) *3

In addition to the standard 300 mm Z-axis travel, the 380 mm Z-axis travel can be selected. The Z-axis travel and the distance between the table top and spindle nose end have been increased to secure ample machining area in the Z-axis direction and improve tool accessibility.

*3. The Z-axis 380 mm spec. cannot be selected for the S300Xd2.

Z-axis travel	
300 mm (standard)	380 mm (optional)
Distance between table top and spindle nose end	
180~480 mm (standard)	150~530 mm (optional)

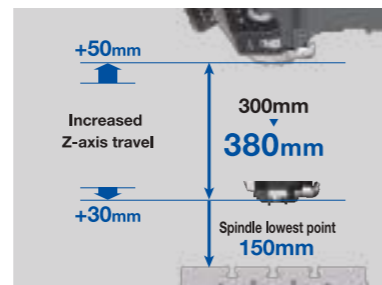

* When Z-axis 380 mm spec. is selected



28-tool magazine *2

This is a compact drum type magazine that achieves high-speed tool change. The magazine can be selected from a 14-tool, 21-tool, or 28-tool magazine. The maximum tool weight is 4 kg.

*2. The 28-tool magazine cannot be selected for the S300Xd2.

28-tool magazine	
Max. tool size	110mm
Max. tool weight	4kg
Max. total tool weight	35kg
Tool-Tool	0.7s

Newly developed and highly efficient 12,000 min⁻¹ spindle motor

The standard motor specifications have been upgraded from the previous 10,000 min⁻¹ to a newly developed 12,000 min⁻¹. As spindle torque is maintained in the medium- and high-speed range, this achieves further reduction in machining time when performing highly efficient machining of aluminum or steel at high speed.

Motor torque characteristics

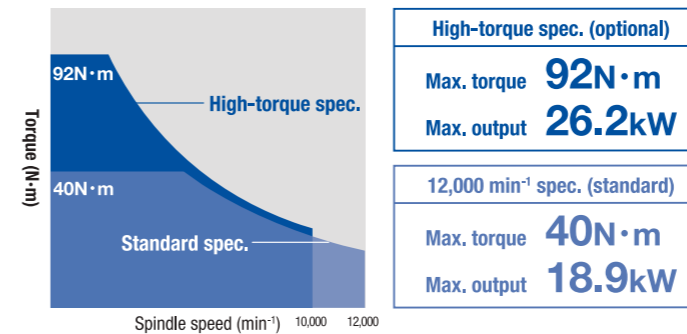

Simultaneous 5-axis machining *4

Provided with functions required for simultaneous 5-axis machining, including tool center point control where machining is performed by changing the tool direction relative to the workpiece, look-ahead max. 1,000 blocks, and submicron command.

*4. Available only on the S300/S500/S700Xd2-5AX.

Comparison with cycle time by a competitor's BT40 MC
 Workpiece: Impeller

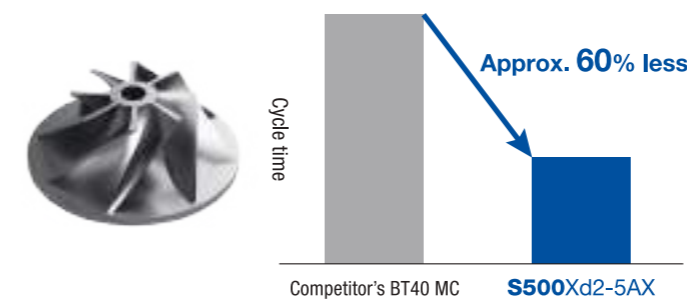

Saving power

New functions, including chip shower energy savings operation, energy savings mode, and no warmup support function, have been incorporated to significantly reduce power consumption, compared to the previous model. Together with various energy-saving technologies, such as power regeneration and highly efficient spindle motors, power consumption is overwhelmingly low.

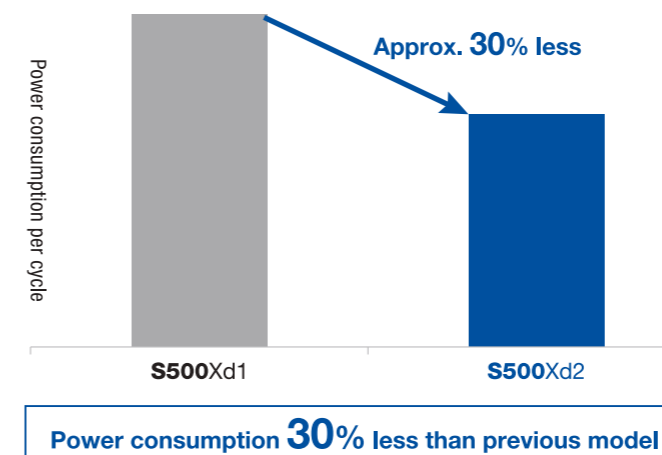

* Values taken by running sample program created by Brother with "chip shower energy savings operation" enabled

Improved spindle rigidity

For 10,000 min⁻¹ high-torque specifications (optional), the spindle bearing diameter has been enlarged to enhance rigidity. The machine demonstrates its capabilities in a wide variety of machining applications, including heavy-duty machining of steel.

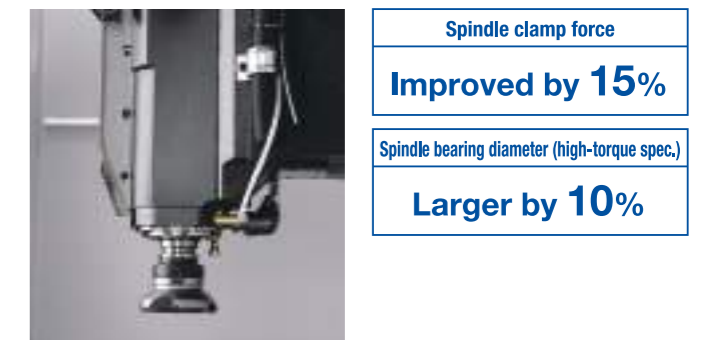

No warmup support function

Provided with an original measurement processing function that reduces the number of actual measurements by a touch probe according to the size of displacement. This eliminates the need for warmup operation, minimizing effects on productivity to achieve highly accurate machining.

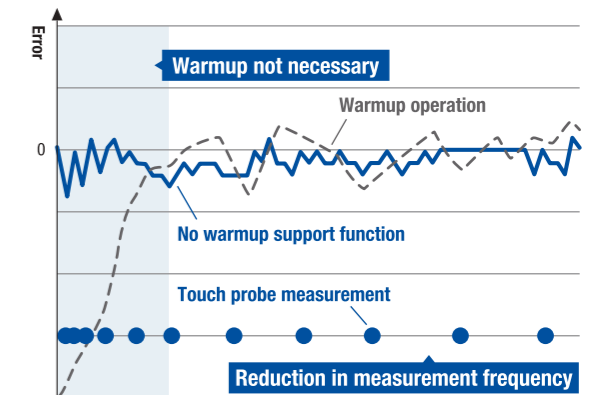

Chip shower energy savings operation

This function controls the on/off timing of the chip shower pump. Operation is switched via parameters according to the amount of chips discharged, contributing to energy saving for chip shower pumps that consume significant amounts of power.

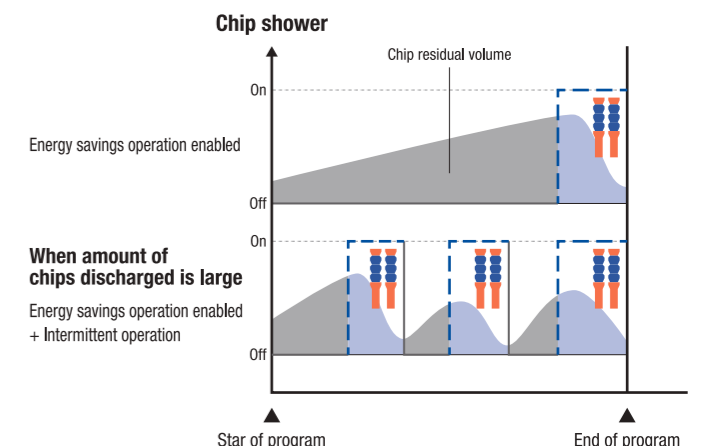

W

Wide travel model with the largest machining area among BT30 spindle machines
Unprecedented large machining area enables highly productive machining from small to large parts

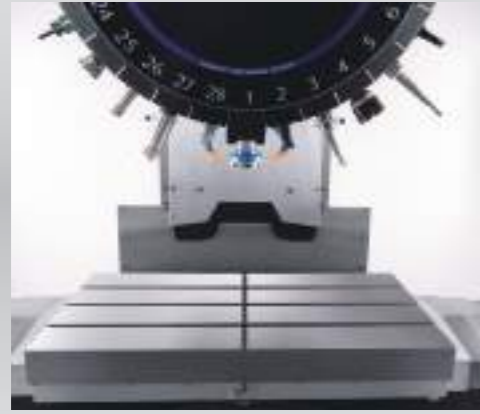

W1000Xd2



R

Non-stop machining model equipped with a pallet changer
Extensive magazine variation further promotes process integration



R450Xd1



R650Xd1



A variety of machining from small to large workpieces

Machine's abilities to handle large workpieces and multi-type small-volume products have been further enhanced by the largest travels of any BT30 machines at X1,000 mm and Y500 mm, maximum loading capacity of 500 kg, and increased Z-axis travel.

Ample travels and table size

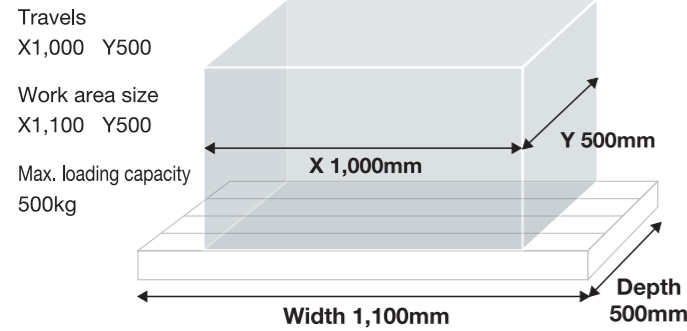

Increased Z-axis travel

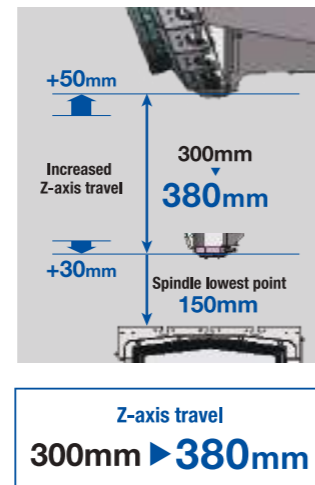

Machining of large workpieces



Multi-part machining of small workpieces



A broad range of machining

The machine can perform a broader range of machining with the newly developed 28-tool magazine (optional), newly developed 12,000 min⁻¹ standard spindle motor, and improved spindle rigidity for high-torque specifications.

28-tool magazine



High-power spindle motor

Motor torque characteristics

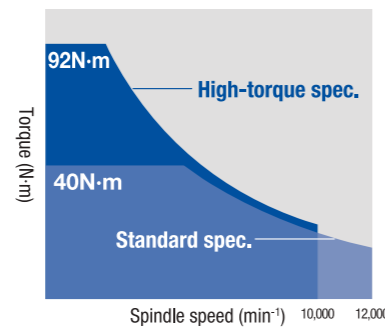

Improved spindle rigidity



Spindle bearing diameter (High-torque spec.) **Larger by 10%**

Non-stop machining

The QT (Quick Turn) table is a turntable type high-speed 2-face pallet changer. Optimized acceleration/deceleration control achieves much faster pallet change. To ensure high reliability, effects by chips etc. are minimized by a turntable that avoids lift-up motion and has a sealed structure, and positioning accuracy is maintained by the stopper mechanism. Workpieces on one pallet can be changed while machining workpieces on the other pallet. Waste in workpiece change time is eliminated, enabling non-stop machining.

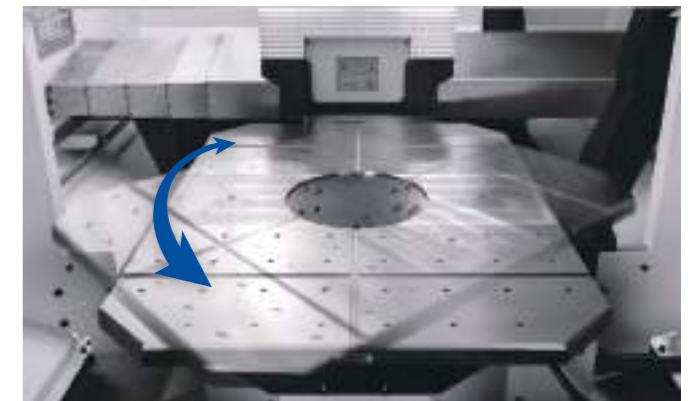
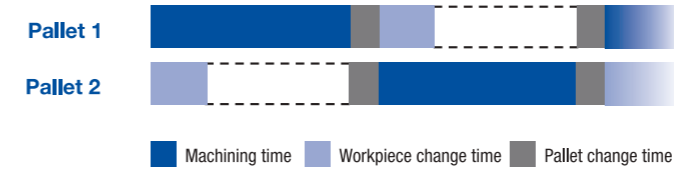

Pallet change time	R450Xd1	2.7s
	R650Xd1	3.1s

Large jig area

Even if the jig protrudes from the table, it can be mounted as long as it is within the pallet turning diameter. The jig area can be further expanded by selecting a low table option that increases the jig height or a turning diameter enlargement option that increases the jig space.

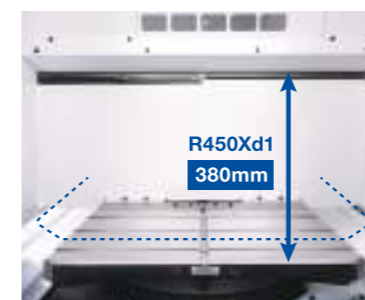

Max. jig height *1	
R450Xd1	380mm
R650Xd1	450mm

*1. The values shown here are for low table specifications.

Extensive magazine variation *2 (14/22/28/40-tool magazines)

In addition to 14-, 22-, and 40-tool magazines, a newly developed 28-tool magazine is available. This promotes process integration, taking advantage of a 2-face pallet changer, and encourages productivity improvement.



*2. The 40-tool magazine is only available for the R650Xd1.

M

Mass production type multi-tasking machine encourages process integration
 Newly developed magazine and new controller further encourage process integration



(Awarded to M200Xd1)

U

Equipped with tilting rotary table with jig area of max. $\phi 500$ mm
 Performs universal indexing, encouraging process integration



Complex machining

Turning and milling can be completed through one-time chucking on one machine. There is no handling between turning and milling, leading to various advantages.

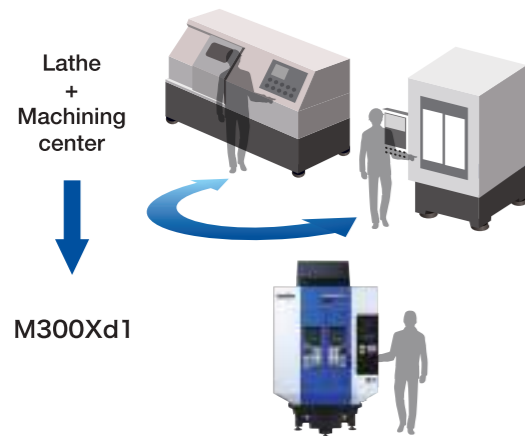

Machine structure

A roller gear cam is used for the tilt axis (A-axis), a DD motor for the turning spindle (C-axis), and an original double plunger lock to secure turning tools.

Turning spindle (C-axis)



A high-speed and high-power built-in DD motor is used for the turning spindle (C-axis). Enabling efficient turning and high-speed indexing.

Double plunger lock



An original double plunger lock is used to secure turning tools, achieving excellent tool change repeatability.

Process integration for multi-face machining

Less space achieved although the machine is equipped with a high-speed and highly accurate tilting rotary table with ample jig area and a newly developed 28-tool magazine. One-clamp machining encourages process integration.

Tilting rotary table

Roller gear cam mechanism is used for A and C axes, achieving high retention strength and backlash-free high-speed and highly accurate indexing.

Max. rotary speed	
A-axis	50 min ⁻¹
C-axis	75 min ⁻¹
0 to 90-deg. indexing time	
A-axis	0.9s
C-axis	1.2s

Increased Y/Z-axis travels

Increased Y- and Z-axis travels provide ample machining area and better tool accessibility.

Z-axis travel	300 mm (previous model)	▶	380mm
Y-axis travel	400 mm (previous model)	▶	450mm

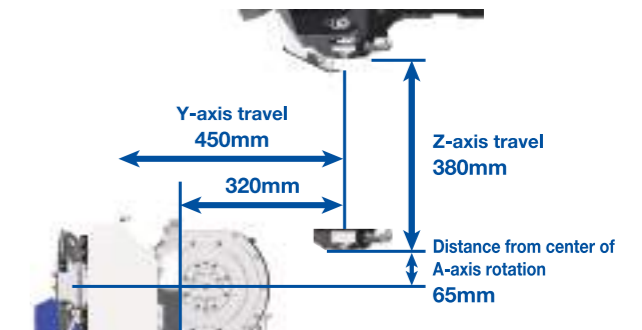

Simultaneous 5-axis machining *1

Provided with functions required for simultaneous 5-axis machining, including tool center point control where machining is performed by changing the tool direction relative to the workpiece, look-ahead max. 1,000 blocks, and submicron command.



Artificial bone

Spindle/turning spindle synchronized control (optional)

Synchronized rotation of the spindle and turning spindle at the instructed rotation ratio enables gear cutting, such as hobbing and skiving.



Skiving

A-axis clamp (optional)

The mechanical clamp plus servo clamp method enables the machine to demonstrate high machining capabilities in high-load machining and stable lathe turning, improving machining accuracy. A double type clamp mechanism, where clamps are provided on the left and right sides, is available to further enhance high machining capabilities.

A-axis clamp torque	
Single	695N·m
Double	975N·m

Expanded jig area

Increased Y- and Z-axis travels provide ample jig area of up to 500 mm in diameter and 320 mm in height. This enables multi-face machining for medium-sized workpieces.

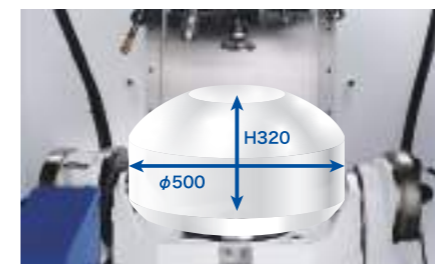

28-tool magazine

A newly developed compact drum type 28-tool magazine takes over fast tool change performance. (14- and 21-tool magazines are also available.)



Simultaneous 5-axis machining *1

Provided with functions required for simultaneous 5-axis machining, including tool center point control where machining is performed by changing the tool direction relative to the workpiece, look-ahead max. 1,000 blocks, and submicron command.

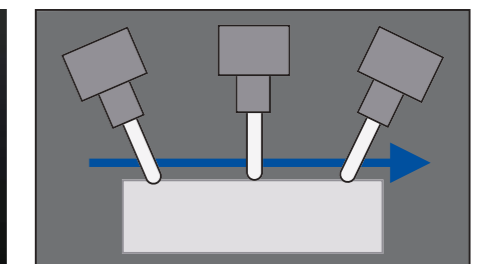

*1. Available only on the U500Xd2-5AX

*1. Available only on the M200Xd1-5AX/M300Xd1-5AX

H

Ample jig area and a newly developed magazine enable multi-face machining of large or long workpieces.
New style of SPEEDIO
Horizontal Compact Machining Center now available



H550Xd1

B-axis table (standard) and ample jig area

The B-axis table with a roller gear cam mechanism is provided standard, achieving an ample jig area of $\phi 600 \times 580$ mm. *1
 The jig area can be expanded to $\phi 800$ mm by moving the tool to a safe position, etc. *2
 The maximum table loading capacity is 400 kg.

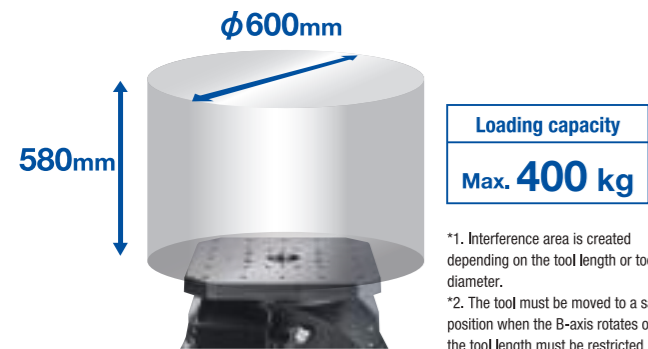

*1. Interference area is created depending on the tool length or tool diameter.
 *2. The tool must be moved to a safe position when the B-axis rotates or the tool length must be restricted.

Space saving

Machine dimensions are 1,557 mm in width and 2,990 mm in depth, achieving reduction in space while maintaining ample jig and machining areas.



Installation space
4.7m² *3

Approx. 20% less *4

Width **1,557mm**

Depth **2,990mm *3**

*3. Dimension including coolant tank
 *4. Compared to BT40 horizontal MC with equivalent travels

Chip evacuation performance

Designed to prevent problems caused by chips by enhancing chip evacuation performance with a magazine cover that separates the magazine from the machining area, a center trough structure, and a head shower (optional) that removes chips from the spindle head.

Center trough structure



Head shower



30-tool magazine

Equipped with the newly developed direct ATC type 30-tool magazine. Supports maximum tool length of 250 mm, maximum tool diameter of 125 mm, and maximum tool weight of 4 kg, enabling a variety of machining, including long workpieces.



Further enhancing productivity in multi-face machining

Special option for SPEEDIO Rotary Table

Using roller gear cam mechanism

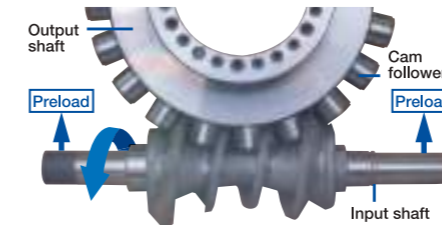

T-200Ad



High productivity

Provides high acceleration and high rotation speed to ensure smooth operation even for jigs with large unbalanced load.

High accuracy

Achieves backlash-free operation by applying preload between the input and output shafts.

Maintenance free

There is very little wear as the input and output shafts make rolling contact. Adjustment is not necessary for long periods.

Main specifications

Type	Right-handed, Left-handed *1	Gear ratio	1/20	Maximum loading capacity	100 (200 *3) kg
Center height	170 mm	Maximum speed	100 (50 *2) min ⁻¹	Product weight	61 kg
Applicable models *4 *5	T-200Ad (for CNC-D00)	S300Xd2 / S500Xd2 / S700Xd2 / W1000Xd2 / R450Xd1 / R650Xd1 / S500Zd1 / S700Zd1 / R450Zd1 / W1000Zd2			

*1. Only right-handed type available for R450Xd1, R650Xd1, and R450Zd1. *2. When high inertia mode (enabled by changing parameter setting) is used. *3. When support table is used. *4. T-200Ad can also be used for S300Xd1, S500Xd1, S700Xd1, W1000Xd1, and W1000Zd1. *5. T-200A for CNC-C00 is also available. T-200A can be used for S300X2/X1, S500X2/X1, S700X2/X1, R450X2/X1, R650X2/X1, F600X1, S500Z2N, S700Z2N, and R450Z1. *6. S500Z2N, S700Z2N, R450Z1, S500Zd1, S700Zd1, R450Zd1, W1000Zd1, and W1000Zd2 sold only in China.

Simple & Compact Manpower saving system with easy introduction and setup

Special option for SPEEDIO Loading System

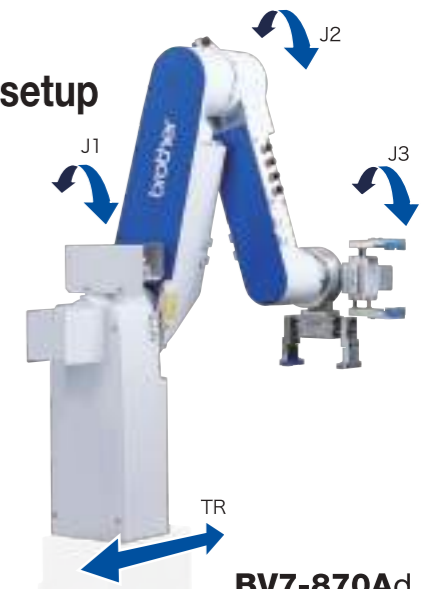

BV7-870Ad

Integrated with the SPEEDIO

Standard equipped with a side door, and can be installed in less space.

Specialized for loading/unloading workpieces

Simple structure with easy handling 4-axis articulated arm.

Controller incorporated in SPEEDIO's control box

Signal connection with machine's NC completed. Both piping and wiring stored in the body.

Main specifications

No. of axes	4 (3 rotary axes, 1 travel axis)	Arm length	Total 870 mm	Applicable models	S300Xd2 / S500Xd2 / M200Xd1
Loading position	Right side / Left side	Rated transferable weight	7 kg		

Machine specifications

Item	S300Xd2 S300Xd2 RD *9 S300Xd2-5AX S300Xd2-5AX RD *9		S500Xd2 S500Xd2 RD *9 S500Xd2-5AX S500Xd2-5AX RD *9		S700Xd2 S700Xd2 RD *9 S700Xd2-5AX S700Xd2-5AX RD *9		W1000Xd2/W1000Xd2 RD *9	
	CNC-D00 CNC-D00v (DB)							
CNC unit	CNC-D00 CNC-D00v (DB)						CNC-D00	
Travels	X axis mm(inch)	300 (11.8)		500 (19.7)		700 (27.6)		1,000 (39.4)
	Y axis mm(inch)	450 (17.7)						500 (19.7)
	Z axis mm(inch)	300 (11.8)		380 (15.0)		300 (11.8) 380 (15.0)		380 (15.0)
Table	Work area size mm(inch)	600 x 450 (23.4 x 17.7)				800 x 450 (31.4 x 17.7)		1,100 x 500 (43.3 x 19.7)
	Max. loading capacity (uniform load) kg(lbs)	250 [300 *6] (551 [661 *6])		250 [400 *6] (551 [881 *6])		300 [500 *6] (661 [1,102 *6])		
Spindle	Spindle speed min ⁻¹	12,000min ⁻¹ specifications: 1~12,000, 16,000min ⁻¹ specifications (optional): 1~16,000, 10,000min ⁻¹ high-torque specifications (optional): 1~10,000, 27,000min ⁻¹ specifications (optional): 1~27,000 (27,000min ⁻¹ specifications cannot be selected for Z-axis 380 mm specifications models)						12,000min ⁻¹ specifications: 1~12,000, 10,000min ⁻¹ high-torque specifications (optional): 1~10,000, 16,000min ⁻¹ specifications (optional): 1~16,000
	Speed during tapping min ⁻¹	MAX. 6,000 (27,000min ⁻¹ specifications: MAX. 8,000)						MAX. 6,000
	Tapered hole	7/24 tapered NO.30						7/24 tapered NO.30
	BT dual contact spindle (BIG-PLUS)	Optional						Optional
	Coolant through spindle (CTS)	Optional (CTS cannot be selected for 27,000min ⁻¹ specification models)						Optional
Feed rate	Rapid traverse rate (XYZ-area) m/min(inch/min)	50 x 50 x 56 (1,969 x 1,969 x 2,205)						50 x 50 x 56 (1,969 x 1,969 x 2,205)
	Cutting feed rate mm/min(inch/min)	X, Y, Z: 1~30,000 (0.04~1,181) *7						X, Y, Z: 1~30,000 (0.04~1,181) *7
ATC unit	Tool shank type	MAS-BT30						MAS-BT30
	Pull stud type *4	MAS-P30T-2						MAS-P30T-2
	Tool storage capacity pcs.	14 / 21		14 / 21 / 28		14 / 21 / 28		14 / 21 / 28
	Max. tool length mm(inch)	160 (6.3) [21 tool] 250 (9.8) [14 tool]		250 (9.8)		250 (9.8)		250 (9.8)
	Max. tool diameter mm(inch)	110 (4.3)						110 (4.3)
	Max. tool weight *1 kg(lbs)	3.0 (6.6) [4.0 (8.8)*10] / tool, (TOTAL TOOL WEIGHT: 25 (55.1) for 14 tools, 35 (77.2) for 21 or 28 tools)						3.0 (6.6) [4.0 (8.8)*10] / tool, (TOTAL TOOL WEIGHT: 25 (55.1) for 14 tools, 35 (77.2) for 21 or 28 tools)
	Tool selection method	Random shortcut method						Random shortcut method
Tool *5 change time	Tool To Tool sec	0.6 / 0.7 (14 or 21 tools / 28 tools)						0.6 / 0.7 (14 or 21 tools / 28 tools)
	Chip To Chip sec	Z-axis 300mm specifications: 1.2 / 1.3 (14 or 21 tools / 28 tools) Z-axis 380mm specifications: 1.3 / 1.4 (14 or 21 tools / 28 tools)						1.3 / 1.4 (14 or 21 tools / 28 tools)
Electric motor	Main spindle motor (10min/continuous) *2 kW	12,000min ⁻¹ specifications: 10.1/7.0, 16,000min ⁻¹ specifications (optional): 7.4/5.1 10,000min ⁻¹ high-torque specifications (optional): 12.8/9.2, 27,000min ⁻¹ specifications (optional): 8.9/6.3						12,000min ⁻¹ specifications: 10.1/7.0, 10,000min ⁻¹ high-torque specifications (optional): 12.8/9.2, 16,000min ⁻¹ specifications (optional): 7.4/5.1
	Axis feed motor kW	X,Y axis: 1.0 Z axis: 2.0						X, Y axis: 1.0 Z axis: 2.0
Power source	Power supply	AC 200 to 230 V±10%, 3-phase, 50/60Hz±2%						AC 200 to 230 V±10%, 3-phase, 50/60Hz±2%
	Power capacity (continuous) kVA	12,000min ⁻¹ specifications: 9.5, 16,000min ⁻¹ specifications (optional): 9.5 10,000min ⁻¹ high-torque specifications (optional): 10.4, 27,000min ⁻¹ specifications (optional): 9.5						12,000min ⁻¹ specifications: 9.5, 10,000min ⁻¹ high-torque specifications (optional): 10.4, 16,000min ⁻¹ specifications (optional): 9.5
	Air supply Regular air pressure MPa Required flow L/min	0.4~0.6 (recommended value 0.5MPa *8) 40 (27,000min ⁻¹ specifications: 115)						0.4~0.6 (recommended value 0.5MPa *8) 45
Machine dimensions	Height mm(inch)	Z-axis 300 mm specifications: 2,529 (99.6) Z-axis 380mm specifications: 2,568 (101.1)				2,633 (103.7)		2,633 (103.7)
	Required floor space *11 (with control unit door open) mm(inch)	1,080 x 2,161 [2,999] (42.5 x 85.1 [118.1])		1,560 x 2,081 [2,919] (61.4 x 81.9 [114.9])		2,050 x 2,081 [2,919] (80.7 x 81.9 [114.9])		2,410 x 2,233 [3,071] (94.9 x 87.9 [120.9])
	Weight [with BV7-870Ad] kg(lbs)	2,350 (5,181) [2,650 (5,843)]		2,400 (5,292) [2,700 (5,953)]		2,550 (5,622)		3,350 (7,385)
Accuracy *3	Accuracy of bidirectional axis positioning (ISO230-2:1988) mm(inch)	0.006~0.020 (0.00024~0.00079)						0.006~0.020 (0.00024~0.00079)
	Repeatability of bidirectional axis positioning (ISO230-2:2014) mm(inch)	Less than 0.004 (0.00016)						Less than 0.004 (0.00016)
Front door	2doors						2doors	
Standard accessories	Instruction Manual (DVD 1 set), leveling bolts (4 pcs.), leveling plate (4 pcs.)							

*1. Actual tool weight differs depending on the configuration and center of gravity. The figures shown here are for reference only. *2. Spindle motor output differs depending on the spindle speed. *3. Measured in compliance with ISO standards and Brother standards. Please contact your local distributor for details. *4. Brother specifications apply to the pull studs for CTS. *5. Measured in compliance with JIS B6336-9 and MAS011-1987. *6. Parameter adjustment is required. (Acceleration adjustment and positioning speed are also changed according to the weight.) *7. When using high accuracy mode B. *8. Regular air pressure varies depending on the machine specifications, machining program details, or use of peripheral equipment. Set the pressure higher than the recommend value. *9. The machine needs to be equipped with a relocation detection device depending on the destination. Machines equipped with a relocation detection device come with "RD" at the end of the model name. *10. Parameter setting must be changed. (Tool magazine indexing time will change.) Max. tool weight 4.0kg cannot be available for the 27,000min⁻¹ specifications. *11. The value does not include the coolant tank.

- Please read the instruction manuals and safety manuals before using Brother products for your own safety. When using oil-based coolant oil or when machining the materials which can cause a fire (ex. Magnesium, resin material), customers are requested to take thoroughgoing safety measures against fire. Depending on the types of cutting material, cutting tools, coolant oil, lubrication oil, it may have an influence on the machine lifecycle. Further questions, please contact our sales representative in charge.
- Leave 700 mm between machines as a maintenance space.

Machine specifications

Item	R450Xd1/R450Xd1 RD *12		R650Xd1/R650Xd1 RD *12	
			14/22/28 tool magazine	40-tool magazine
CNC Unit	CNC-D00		CNC-D00	
Travels	X axis mm(inch)	450 (17.7)		650 (25.6)
	Y axis mm(inch)	320 (12.6) *7		400 (15.7)
	Z axis mm(inch)	305 (12.0)		435 (17.1)
Table	Distance between table top and spindle nose end mm(inch)	200~505 (7.9~19.9)[280~585 (11.0~23.0) *8]		250~555 (9.8~21.8) [350~655 (13.8~25.8) *8] 250~685 (9.8~27.0) [350~785 (13.8~30.9) *8]
	Work area size mm(inch)	One face 600 x 300 (23.6 x 11.8)		One face 800 x 400 (31.5 x 15.7)
Table	Max. loading capacity (uniform load) kg(lbs)	One face 120 (265) [200(441) *6]		One face 200 (441) [300 (661) *6]
	Position time sec.	2.7 *11		3.1 *11 3.1 *11
Spindle	Spindle speed min ⁻¹	10,000min ⁻¹ specifications: 1~10,000 16,000min ⁻¹ specifications(optional): 1~16,000 10,000min ⁻¹ high-torque specifications(optional): 1~10,000		10,000min ⁻¹ specifications: 1~10,000 16,000min ⁻¹ specifications(optional): 1~16,000 10,000min ⁻¹ high-torque specifications(optional): 1~10,000
	Speed during tapping min ⁻¹	MAX. 6,000		MAX. 6,000
	Tapered hole	7/24 tapered No.30		7/24 tapered No.30
	BT dual contact system(BIG-PLUS)	Optional		Optional
Feed rate	Coolant Through Spindle(CTS)	Optional		Optional
	Rapid traverse rate(XYZ-area) m/min(inch/min)	50 x 50 x 50 (1,969 x 1,969 x 1,969)		50 x 50 x 50 (1,969 x 1,969 x 1,969)
ATC unit	Cutting feed rate mm/min(inch/min)	X, Y, Z axis : 1~30,000 (0.04~1,181) *9		X, Y, Z axis : 1~30,000 (0.04~1,181) *9
	Tool shank type	MAS-BT30		MAS-BT30
Tool *5 change time	Pull stud type *4	MAS-P30T-2		MAS-P30T-2
	Tool storage capacity pcs.	14 / 22 / 28		14 / 22 / 28 40
	Max. tool length mm(inch)	200 (7.9)		200 (7.9) 250 (9.8)
	Max. tool diameter mm(inch)	80 (3.1)		80 (3.1) 55 (2.1) / 125 (4.9) No adjacent tool
	Max. tool weight *1 kg(lbs)	3.0 (6.6) (total tool weight : 25 (55.1) for 14-tool, 40 (88.2) for 22/28 tool->		3.0 (6.6) (total tool weight: 25 (55.1) for 14-tool, 40 (88.2) for 22/28 tool-> 4.0 (8.8) <total tool weight: 80 (176.3) >
	Tool selection method	Random short cut method		Random short cut method Double arm method (random closet path)
	Tool To Tool sec	0.6 / 0.7 (14-tool / 22 or 28 tool)		0.6 / 0.8 (14-tool / 22 or 28 tool) 0.9
Chip To Chip sec	1.3 / 1.5 (14-tool / 22 or 28 tool)		1.4 / 1.5 (14-tool / 22 or 28 tool) 2.5	
Electric motor	Main spindle motor (10min/continuous) *2 kW	10,000min ⁻¹ specifications: 10.1 / 7.0 16,000min ⁻¹ specifications: 7.4 / 5.1 10,000min ⁻¹ high-torque specifications: 12.8 / 9.2		10,000min ⁻¹ specifications: 10.1 / 7.0 16,000min ⁻¹ specifications: 7.4 / 5.1 10,000min ⁻¹ high-torque specifications: 12.8 / 9.2
	Axis feed motor kW	X, Y axis: 1.0 Z axis: 1.8		X, Y axis: 1.0 Z axis: 1.8
Power source	Power supply	AC 200 to 230 V±10%, 3-phase, 50/60Hz±2%		AC 200 to 230 V±10%, 3-phase, 50/60Hz±2%
	Power capacity (continuous) kVA	10,000min ⁻¹ specifications: 9.5 16,000min ⁻¹ specifications: 9.5 10,000min ⁻¹ high-torque specifications: 10.4		10,000min ⁻¹ specifications: 9.5 16,000min ⁻¹ specifications: 9.5 10,000min ⁻¹ high-torque specifications: 10.4
	Air supply Regular air pressure MPa Required flow L/min	0.4~0.6 (recommended value : 0.5MPa *10) 45		0.4~0.6 (recommended value: 0.5MPa *10) 45 100
Machine dimensions	Height mm(inch)	2,584 (101.7)		2,704 (106.5)
	Required floor space *13 (with control unit door open) mm(inch)	1,400 x 2,609 [3,448] (55.1 x 102.7 [135.7])		1,830 x 3,029 [3,868] (72.0 x 119.3 [152.3]) 2,145 x 3,029 [3,868] (84.4 x 119.3 [152.3])
	Weight kg(lbs)	2,750 (6,063)		3,550 (7,826) 4,150 (9,149)
Accuracy *3	Accuracy of bidirectional axis positioning(ISO230-2:1988) mm(inch)	0.006~0.020 (0.00024~0.00079)		0.006~0.020 (0.00024~0.00079)
	Repeatability of bidirectional axis positioning(ISO230-2:2014) mm(inch)	Less than 0.004 (0.00016)		Less than 0.004 (0.00016)
Front door	2doors		2doors	
Standard accessories	Instruction Manual (DVD 1 set), leveling bolts (4 pcs.), leveling plate (4 pcs.) [R650Xd1: 5 pcs.] [R650Xd1: 5 pcs.]			

*1. Actual tool weight differs depending on the configuration and center of gravity. The figures shown here are for reference only. *2. Spindle motor output differs depending on the spindle speed. *3. Measured in compliance with ISO standards and Brother standards. Please contact your local distributor for details. *4. Brother specifications apply to the pull studs for CTS. *5. Measured in compliance with JIS B6336-9 and MAS011-1987. *6. Can be increased up to R450Xd1: 200kg, R650Xd1: 300kg (one face) by changing the parameter. Please consult us separately. *7. When using the hydraulic rotary joint, the Y-axis travel becomes 290 mm. *8. Values when the low-floor table is selected. *9. When using high accuracy mode B. *10. Regular air pressure varies depending on the machine specifications, machining program details, or use of peripheral equipment. Set the pressure higher than the recommend value. *11. When table loading on one face is R450Xd1: 120kg, R650Xd1: 200kg. *12. The machine needs to be equipped with a relocation detection device depending on the destination. Machines equipped with a relocation detection device come with "RD" at the end of the model name. *13. The value does not include the coolant tank or chip conveyor.

- When exporting our machine together with additional 1-axis rotary table or compound rotary table (including cases where a rotary table is scheduled to be installed overseas), or exporting the M200/M300Xd1, U500Xd2, S300/S500/S700Xd2-5AX, or H550Xd1, the machine is deemed to be included in the "applicable listed items" controlled by the Foreign Exchange and Foreign Trade Law of Japan. When exporting the machine, please obtain required permissions, including an export license, from the Ministry of Economy, Trade and Industry (METI) or Regional Bureaus of Economy, Trade and Industry before shipment. When re-selling or re-exporting the machine, you may need to obtain permissions from METI, and the government of the country where the machine is installed.
- When exporting our machine together with compound rotary table (including cases where a rotary table is scheduled to be installed overseas), exporting the M200/M300Xd1, U500Xd2, or S300/S500/S700Xd2-5AX, or exporting the H550Xd1 together with additional 1-axis rotary table (including cases where a rotary table is scheduled to be installed overseas), as a machine conforming to Row 2 of Appended Table 1 of Export Trade Control Order, a relocation detection device is installed on the machine depending on the destination country. After relocating the machine with the detection device, the machine is locked and any operation is temporarily impossible. Please inform your local distributor of machine relocation in advance and apply to perform the release operation of relocated machine.
- In order to operate our machine with an additional axis rotary table installed separately overseas after exporting the machine, a procedure to activate the axis of the rotary table is needed. Please inform your local distributor of these processes in advance, because the predetermined procedure is required to perform the activation. In addition, for export to some countries and regions other than "Group A countries", it is not possible to install a compound rotary table on the machine or an additional 1-axis rotary table on the H550Xd1 separately overseas after exporting the machine. Please make sure you obtain an export license for the machine together with compound rotary table, or additional 1-axis rotary table for the H550Xd1, before shipment.

Machine specifications

Item		M200Xd1 / M200Xd1 RD *8	M200Xd1-5AX / M200Xd1-5AX RD *8	M300Xd1 / M300Xd1 RD *8	M300Xd1-5AX / M300Xd1-5AX RD *8
CNC Unit		CNC-D00	CNC-D00v (DB)	CNC-D00	CNC-D00v (DB)
Travels	X axis mm(inch)	200 (7.9)		300 (11.8)	
	Y axis mm(inch)	440 (17.3)		440 (17.3)	
	Z axis mm(inch)	305 (12.0)		380 (15.0)	
	A axis deg.	-30~120		-30~120	
	C axis deg.	360		360	
	Distance between table top and spindle nose end mm(inch)	150~455 (5.9~17.9)		150~530 (5.9~20.9)	
Table	Work area size mm(inch)	ø140 (ø5.5)		ø170 (ø6.7)	
	Shape of table top	In compliance with table nose No.5 of ISO702-4 (JISB6109-2)		In compliance with table nose No.6 of ISO702-4 (JISB6109-2)	
	Max. loading capacity (uniform load) kg(lbs)	Table side 40 (88.2) / Tale side 19 (41.9) *9		Table side 75 (165.3) / Tale side 19 (41.9) *9	
	Max. table load inertia kg·m ² (lb·inch ²)	Table side 0.29 (991) / Tale side 0.04 (137)		Table side 0.8 (2,734) / Tale side 0.04 (137)	
Spindle	Spindle speed min ⁻¹	10,000min ⁻¹ specifications: 1~10,000 16,000min ⁻¹ specifications (Optional): 1~16,000			
	Speed during tapping min ⁻¹	MAX. 6,000			
	Tapered hole	7/24 tapered No.30			
	BT dual contact system (BIG-PLUS)	Optional			
	Coolant Through Spindle (CTS)	Optional			
Turning spindle	Max. Spindle speed min ⁻¹	2,000		1,500	
Feed rate	Rapid traverse rate (XYZ-area) m/min(inch/min)	50 x 50 x 50 (1,969 x 1,969 x 1,969)			
	Cutting feed rate mm/min(inch/min)	X, Y, Z axis: 1~30,000 (0.04~1,181) *7			
	Indexing feed rate (A and C) min ⁻¹	A axis: 60 C axis: 200		A axis: 50 C axis: 200	
ATC unit	Tool shank type	MAS-BT30			
	Pull stud type *4	MAS-P30T-2			
	Tool storage capacity pcs.	22/28 *10			
	Max. tool length mm(inch)	250 (9.8) *12			
	Max. tool diameter mm(inch)	80 (3.1)			
	Max. tool weight *1 kg(lbs)	3 (6.6) <total tool weight : 40(88.2)>			
	Tool selection method	Random shortcut method			
Tool *5 change time	Tool To Tool sec.	0.8		0.8	
	Chip To Chip sec.	1.4		1.5	
Electric motor	Main spindle motor (10min/continuous) *2 kW	10,000min ⁻¹ specifications: 10.1/7.0 16,000min ⁻¹ specifications (optional): 7.4/5.1			
	Axis feed motor kW	X,Y axis: 1.0 Z axis: 1.8 A axis: 0.8		X,Y axis: 1.0 Z axis: 1.8 A axis: 1.35	
	Turning spindle motor kW	4.2		4.6	
Power source	Power supply	AC 200 to 230 V±10%, 3-phase, 50/60Hz±2%			
	Power capacity (continuous) kVA	10,000min ⁻¹ specifications: 9.5 16,000min ⁻¹ specifications (optional): 9.5			
	Air supply Regular air pressure MPa Required flow L/min	0.4~0.6 (recommended value 0.5MPa *6) 175			
Machine dimensions	Height mm(inch)	2,612 (102.9)		2,733 (107.6)	
	Required floor space *11 mm(inch)	1,280 x 2,667 (50.4 x 105)		1,520 x 2,667 (59.8 x 105)	
	Weight kg(lbs)	2,700 (5,953)		2,850 (6,283)	
*3 Accuracy	Accuracy of bidirectional axis positioning (ISO230-2: 1988) (ISO230-2: 2014)	X, Y, Z axis: 0.006~0.020 mm (0.00024~0.00079 inch) A, C axis: 28 sec or less			
	Repeatability of bidirectional axis positioning (ISO230-2: 2014)	X, Y, Z axis: Less than 0.004 mm (0.00016 inch) A, C axis: 16 sec or less			
Front door		2doors			
Standard accessories		Instruction Manual (DVD 1 set), leveling bolts (5 pcs.), leveling plate (5 pcs.)			

*1. Actual tool weight differs depending on the configuration and center of gravity. The figures shown here are for reference only. *2. Spindle motor output differs depending on the spindle speed. *3. Measured in compliance with ISO standards and Brother standards. *4. Brother specifications apply to the pull studs for CTS. *5. Measured in compliance with JIS B6336-9 and MAS011-1987. *6. Regular air pressure varies depending on the machine specifications, machining program details, or use of peripheral equipment. Set the pressure higher than the recommended value. *7. When using high accuracy mode B. *8. The machine needs to be equipped with a relocation detection device depending on the destination. Machines equipped with a relocation detection device come with "RD" at the end of the model name. *9. The loading capacity on the tail side is 13 kg at the rotating section and 6 kg at the fixed section. *10. For the 28-tool magazine, turning tools cannot be set in adjust pods. *11. The value does not include the coolant tank or chip conveyor. *12. Tools with a length of 200 mm or more may contact the jig when the magazine turns, depending on the jig height.

* Depending on the type of coolant, it may have a significant influence on the machine lifecycle. It is recommended to use the coolant which is commercially designated as high lubricity, for example Emulsion type. Especially, the coolant of chemical solution type (ex. Synthetic type) is prohibited to use, because it may cause machine damages.

* When using CTS (Coolant Through Spindle) function, usage of the coolant of combustible type (ex. Oil-based type) is prohibited.

Machine specifications

Item		U500Xd2 / U500Xd2 RD *8 U500Xd2-5AX / U500Xd2-5AX RD *8	H550Xd1 / H550Xd1 RD *8
CNC Unit		《U500Xd2》 CNC-D00 《U500Xd2-5AX》 CNC-D00v(DB)	CNC-D00
Travels	X axis mm(inch)	500 (19.7)	550 (21.7)
	Y axis mm(inch)	450 (17.7)	400 (15.7)
	Z axis mm(inch)	380 (15.0)	400 (15.7)
	A axis deg.	-30~120	—
	B axis deg.	—	360
	C axis deg.	360	—
	Distance between table top and spindle nose end mm(inch)	115~495 (4.5~19.5)	—
	Distance between table top and spindle center mm(inch)	—	100~500 (3.9~19.7)
	Distance between table center and spindle nose end mm(inch)	—	150~550 (5.9~21.7)
	Table	Work area size mm(inch)	ø260 (ø10.2)
Max. loading capacity (uniform load) kg(lbs)		100 (220)	400 (882) *13
Max. table load inertia kg·m ² (lb·inch ²)		1.8 (6,151) [2.6 (8,885) *9]	3.4 (11,618) [5.4 (18,453) *9]
Spindle	Spindle speed min ⁻¹	12,000min ⁻¹ specifications: 1~12,000 16,000min ⁻¹ specifications (Optional): 1~16,000	12,000min ⁻¹ specifications: 1~12,000 16,000min ⁻¹ specifications (optional): 1~16,000 10,000min ⁻¹ high-torque specifications (optional): 1~10,000
	Speed during tapping min ⁻¹	MAX. 6,000	MAX. 6,000
	Tapered hole	7/24 tapered No.30	7/24 tapered No.30
	BT dual contact system (BIG-PLUS)	Optional	Optional
	Coolant Through Spindle (CTS)	Optional	Optional
Feed rate	Rapid traverse rate (XYZ-area) m/min(inch/min)	50 x 50 x 56 (1,969 x 1,969 x 2,205)	50 x 56 x 56 (1,969 x 2,205 x 2,205)
	Cutting feed rate mm/min(inch/min)	X, Y, Z axis: 1~30,000 (0.04~1,181) *6	X, Y, Z axis: 1~30,000 (0.04~1,181) *6
	Indexing feed rate (A and C) min ⁻¹	A axis: 50 C axis: 75 (60 *9)	—
	Indexing feed rate (B) min ⁻¹	—	100 (85 *9)
ATC unit	Tool shank type	MAS-BT30	MAS-BT30
	Pull stud type *4	MAS-P30T-2	MAS-P30T-2
	Tool storage capacity pcs.	14 / 21 / 28	30
	Max. tool length mm(inch)	250 (9.8)	250 (9.8)
	Max. tool diameter mm(inch)	110 (4.3)	125 (4.9) *12
	Max. tool weight *1 kg(lbs)	3.0 (6.6) [4.0 (8.8) *10] / tool, <TOTAL TOOL WEIGHT: 25 (55.1) for 14 tools, 35 (77.2) for 21 or 28 tools>	4.0 (8.8) / tool, <TOTAL TOOL WEIGHT: 50 (110.2)>
	Tool selection method	Random shortcut method	Random shortcut method
Tool *5 change time	Tool To Tool sec.	0.6 / 0.7 (14 or 21 tools / 28 tools)	1.1
	Chip To Chip sec.	1.3 / 1.4 (14 or 21 tools / 28 tools)	2.4
Electric motor	Main spindle motor (10min/continuous) *2 kW	12,000min ⁻¹ specifications: 10.1/7.0, 16,000min ⁻¹ specifications (optional): 7.4/5.1	12,000min ⁻¹ specifications: 10.1/7.0, 16,000min ⁻¹ specifications (optional): 7.4/5.1 10,000min ⁻¹ high-torque specifications (optional): 12.8/9.2
	Axis feed motor kW	X, Y axis: 1.0 Z axis: 2.0 A axis: 0.9 C axis: 0.55	X, Z axis: 1.0 Y axis: 1.8 B axis: 1.8
	Power supply	AC 200 to 230 V±10%, 3-phase, 50/60Hz±2%	AC 200 to 230 V±10%, 3-phase, 50/60Hz±2%
Power source	Power capacity (continuous) kVA	12,000min ⁻¹ specifications: 9.5, 16,000min ⁻¹ specifications (optional): 9.5	12,000min ⁻¹ specifications: 9.5, 16,000min ⁻¹ specifications (optional): 9.5 10,000min ⁻¹ high-torque specifications (optional): 10.4
	Air supply Regular air pressure MPa Required flow L/min	0.4~0.6 (recommended value 0.5MPa *7) 52	0.4~0.6 (recommended value 0.5MPa *7) 45
	Machine dimensions	Height mm(inch)	2,818 (110.9)
Required floor space *11 [with control unit door open] mm(inch)		1,560 x 2,081 [2,919] (61.4 x 81.9 [114.9])	1,557 x 2,743 [3,581] (61.3 x 108.0 [141.0])
Weight kg(lbs)		2,650 (5,843)	2,850 (6,284)
*3 Accuracy	Accuracy of bidirectional axis positioning (ISO230-2: 1988) (ISO230-2: 2014)	X, Y, Z axis: 0.006~0.020mm (0.00024~0.00079inch) A, C axis: 28 sec or less	X, Y, Z axis: 0.006~0.020 mm (0.00024~0.00079 inch) B axis: 28 sec or less
	Repeatability of bidirectional axis positioning (ISO230-2: 2014)	X, Y, Z axis: Less than 0.004mm (0.00016inch) A, C axis: 16 sec or less	X, Y, Z axis: Less than 0.004 mm (0.00016 inch) B axis: 16 sec or less
Front door		2doors	2doors
Standard accessories		Instruction Manual (DVD 1 set), leveling bolts (4 pcs.), leveling plate (4 pcs.)	

*1. Actual tool weight differs depending on the configuration and center of gravity. The figures shown here are for reference only. *2. Spindle motor output differs depending on the spindle speed. *3. Measured in compliance with ISO standards and Brother standards. *4. Brother specifications apply to the pull studs for CTS. *5. Measured in compliance with JIS B6336-9 and MAS011-1987. *6. When using high accuracy mode B. *7. Regular air pressure varies depending on the machine specifications, machining program details, or use of peripheral equipment. Set the pressure higher than the recommended value. *8. The machine needs to be equipped with a relocation detection device depending on the destination. Machines equipped with a relocation detection device come with "RD" at the end of the model name. *9. When using high inertia mode. Parameter setting needs to be changed. *10. Parameter setting needs to be changed. (Tool indexing time is changed.) *11. The value does not include the coolant tank or chip conveyor. *12. When attaching an adjacent tool, the total diameter of a tool and its adjacent tool must be less than 130 mm. *13. When designing a jig, please pay attention to the maximum table load inertia.

NC unit specifications

Model	S300/S500/S700Xd2, W1000Xd2, R450/R650Xd1, M200/M300Xd1, U500Xd2, H550Xd1
CNC model	CNC-D00
Control axes	5 axes (X, Y, Z, 2 additional axes) R450/R650Xd1: 7 axes (X, Y, Z, 4 additional axes) M200/M300Xd1, U500Xd2: 5 axes (X, Y, Z, A, C)
Simultaneously controlled axes (Positioning)	5 axes (X, Y, Z, 2 additional axes) M200/M300Xd1, U500Xd2: 5 axes (X, Y, Z, A, C)
Simultaneously controlled axes (Interpolation)	Linear: 4 axes (X, Y, Z, 1 additional axis) Circular: 2 axes Helical/Conical: 3 axes (X, Y, Z)
Least input increment	0.001 mm, 0.0001 inch, 0.001 deg.
Max. programmable dimension	±999999.999 mm, ±99999.9999 inch
Display	15-inch color LCD touch display
Memory capacity	500 Mbytes, 3 Gbytes (optional) (Total capacity of program and data bank)
External communication	USB memory interface, Ethernet, RS232C (optional)
No. of registrable programs	4,000 (Total capacity of program and data bank)
Program format	NC language, conversation language (changed by parameter) Conversion from conversation language program to NC language program available M200/M300Xd1, H550Xd1: NC language *Conversation language not available

Model	S300/S500/S700Xd2-5AX, M200/M300Xd1-5AX, U500Xd2-5AX
CNC model	CNC-D00v (DB)
Control axes	5 axes (X, Y, Z, 2 additional axes) M200/M300Xd1-5AX, U500Xd2-5AX: 5 axes (X, Y, Z, A, C)
Simultaneously controlled axes (Positioning)	5 axes (X, Y, Z, 2 additional axes) M200/M300Xd1-5AX, U500Xd2-5AX: 5 axes (X, Y, Z, A, C)
Simultaneously controlled axes (Interpolation)	Linear: 5 axes (X, Y, Z, 2 additional axes) M200/M300Xd1-5AX, U500Xd2-5AX: 5 axes (X, Y, Z, A, C) Circular: 2 axes Helical/Conical: 4 axes (3 linear axes + 1 additional axis, 2 linear axes + 2 additional axes)
Least input increment	0.0001 mm, 0.00001 inch, 0.0001 deg.
Max. programmable dimension	±999999.9999 mm, ±99999.99999 inch
Display	15-inch color LCD touch display
Memory capacity	3 Gbytes (Total capacity of program and data bank)
External communication	USB memory interface, Ethernet, RS232C (optional)
No. of registrable programs	4,000 (Total capacity of program and data bank)
Program format	NC language *Conversation language not available

* "Control axes" and "Simultaneously controlled axes" indicate the maximum number of axes, which will differ depending on the shipping destination or machine specifications.
* Ethernet is a registered trademark of Xerox Corporation in the United States.

NC functions

Operation	Dry run Machine lock Program restart Rapid traverse override Cutting feed override Background editing Screen shot Operation level External input signal key Shortcut keys <Optional> Spindle override	Monitoring	Machining load monitoring ATC tool monitoring Overload prediction Waveform display / Waveform output to memory card Heat expansion compensation system II (X, Y, and Z axes) Production performance display Tool life / Spare tool Chip detection function *7 Tap return function Status log	Standby mode	Macro
Programming	Absolute / Incremental Inch / Metric Coordinate system setting Corner C / Corner R Rotational transformation Synchronized tap Subprogram Graphic display	Maintenance	Alarm log Operation log Maintenance notice Motor insulation resistance measurement Tool washing filter with filter clogging detection Battery-free encoder Brake load test	Support apps	Support apps
Measurement	Automatic workpiece measurement *1 Tool length measurement	Automatic / Network	Computer remote OPC UA Auto notification Built-in PLC (LD/ST/FBD) <Optional> CC-Link, master station CC-Link, remote device station PROFIBUS-DP, slave DeviceNet, slave PROFINET, slave EtherNet/IP, slave Energy saving Automatic power off	Accessories	Accessories
High speed and high accuracy	Machining parameter adjustment High-accuracy mode All High-accuracy mode BII (Look-ahead 160 blocks) Backlash compensation Tool center point control *3 *4 (Look-ahead 1,000 blocks) <Optional> High accuracy mode BII (Look-ahead 1,000 blocks, smooth path offset)	Functions limited to NC language	Menu programming Local coordinate system Expanded workpiece coordinate system One-way positioning Inverse time feed Programmable data input Tool length compensation Cutter compensation Scaling Mirror image External sub program call	Functions limited to conversation language *6	Turning function *8

*1. Measuring instrument needs to be prepared by users.
*2. When the submicron command is used, changing to the conversation language program is disabled.
*3. There are restrictions on the axis configuration.
*4. Available only on simultaneous 5-axis control (-5AX) models.
*5. Standard on simultaneous 5-axis control (-5AX) models.
*6. Conversation language not available on the M200/M300Xd1 (-5AX), H550Xd1, and simultaneous 5-axis control (-5AX) models.
*7. Not available on the M200Xd1 (-5AX), R450/R650Xd1, and H550Xd1.
*8. Available only on the M200/M300Xd1 (-5AX).

*Depending on the model and specifications, some options may be standard equipment or may not be available. For details, refer to the model catalog.

Coolant tank

	S300Xd2 S500Xd2 S700Xd2	W1000Xd2	R450Xd1	R650Xd1	M200Xd1 M300Xd1	U500Xd2	H550Xd1
Coolant tank 50L	●					●	
Coolant tank 100L	●					●	
Coolant tank 150L	●					●	
Coolant tank 200L	●	●				●	
Coolant tank 150L with chute			●		●		
Coolant tank 200L with chute			●	●			●
Coolant tank 250L with chute				●			
Chip conveyor tank (360~390L)			●	●	●		●

* Coolant tanks other than 50L and 100L can be selected for Coolant Through Spindle CTS 1.5 MPa with cyclone filter. However, some coolant tanks are only available for CTS 1.5MPa with cyclone filter.
* Capacity of the chip conveyor tank differs depending on the model, so please refer to the model catalog for details.

Common options

- BT dual contact spindle
- Coolant Through Spindle (CTS) 3.0MPa *1
- Coolant Through Spindle (CTS) 7.0MPa *1
- Head coolant nozzle
- Tool cleaning system
- Chip shower
- Fixture shower valve unit
- Cleaning gun
- Mesh basket for collecting chips
- Automatic oil lubricator
- Automatic grease lubricator
- Work light, 1 or 2 lamps
- Signal light, 1, 2, or 3 lamps
- Automatic door with switch panel 10 holes
- Area sensor
- Side cover with transparent window
- Specified color
- Tool breakage detector, touch type
- Manual pulse generator with enable switch
- Spindle override
- Switch panel 8 or 10 holes
- Power supply expansion 50A
- RS232C 25-pin connector at control box
- Master on circuit
- 100V outlet in control box
- Data protection switch, key type
- Parts name sticker set
- Origin alignment mark
- Transformer box
- Memory expansion 3GB
- PLC programming software for D00
- EXIO board assembly
- ① EXIO board, input32/output32, additional #1
- ② EXIO board, input32/output32, additional #2
- Industrial network
- ① CC-Link, master station
- ② CC-Link, remote device station
- ③ PROFIBUS DP, slave
- ④ DeviceNet, slave
- ⑤ PROFINET, slave
- ⑥ EtherNet/IP, slave
- High accuracy mode B II
(Look-ahead 1,000 blocks, smooth path offset)
- Submicron command
- Interrupt type macro
- Rotary fixture offset
- Feature coordinates setting
- Involute interpolation

*1. the coolant tank is not included.

Model-specific options

	S300Xd2 S500Xd2 S700Xd2	W1000Xd2	R450Xd1	R650Xd1	M200Xd1 M300Xd1	U500Xd2	H550Xd1
Rotary table T-200Ad	●	●	●	●			
Column coolant nozzle	●	●	●	●			
High column, 150mm, 250mm, or 350mm *2	●	●					
Side shutter	●					●	
Additional axis cable	●	●	●	●			
Top cover	●	●	●	●		●	
Grip cover for tool magazine	●	●	●	●	●	●	
Breaker handle cover	●					●	
Side door with transparent window			●		●	●	
Folding door (two-door)	●	●	●	●		●	●
Pneumatic relay box 12P			●	●			
Hydraulic rotary joint 4P			●	●			
Rotary joint 4P					●		
Hydraulic rotary cylinder					●		
A-axis clamp (Single · Double)					●		
Rotary joint 6P						●	
Rotary joint 9+1P							●
Table light			●	●			
Outside rotary table switch for 1 or 2 axes			●	●			
Rotary table switch (for B-axis)							●
Turning diameter enlargement, ø1,100mm (R450Xd1)/ø1,300mm (R650Xd1)			●	●			
Low-floor table			●	●			
Side magazine switch			●				
Front switch panel 10 holes				●			●
Outside start switch on the side				●			
Spindle/turning spindle synchronized control					●		

*2. 350mm high column is only available for W1000Xd2.

DG-1

Mechanizes manual deburring of die casting material in variable-type variable-volume production

Deburring Center



Mechanization of manual deburring of die casting material

Deburring of die casting material in variable-type variable-volume production is currently performed manually. Deburring setup functions achieved by Brother's original technology enable efficient mechanization of manual deburring.

Equipped with pickup type ATC

The pickup type ATC can store six tools, and various types of deburring tools can be used. The open/close magazine cover minimizes the impact of chips.



Die casting parts manufacturing processes



Brother's original deburring setup functions

Brother's original deburring setup functions, including teaching representative points, automatic machining path creation based on these points, path correction by intuitive operation and automatic machining program conversion, achieve fast deburring setup.



Teaching main representative points

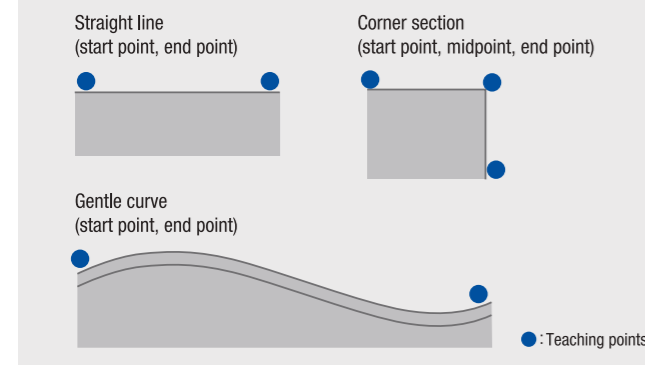

Machining path creation image

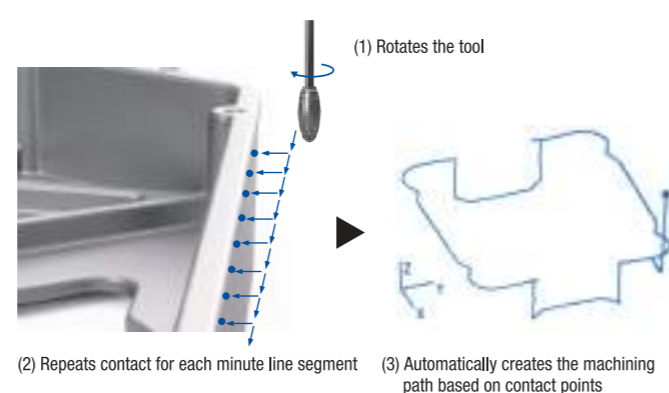

Machine specifications

Item		Deburring Center DG-1	
CNC Unit		CNC-D00	
Travels	X axis	mm(inch)	500 (19.7)
	Y axis	mm(inch)	300 (11.8)
	Z axis	mm(inch)	275 (10.8)
	A axis	deg.	360
	Distance between A-axis rotation center and spindle nose end	mm(inch)	80~355 (3.1~14.0)
Table	Max. loading capacity	kg(lbs)	50 (110)
	Max. table load inertia	kg·m ² (lb·inch ²)	0.7 (2,392)
Spindle	Spindle speed	min ⁻¹	1~20,000
	Tapered hole		7/24 tapered No.15
Feed rate	Rapid traverse rate (XYZ-area)	m/min(inch/min)	40 x 40 x 40 (1,575 x 1,575 x 1,575)
	Cutting feed rate	mm/min(inch/min)	X, Y, Z axis: 1~30,000 (0.04~1,181) *6
	Indexing feedrate (A)	min ⁻¹	100
ATC unit	Tool shank type		JBS4002-15T
	Pull stud type *3		JBS4002-15P (45°)
	Tool storage capacity	pcs.	6
	Max. tool length	mm(inch)	150 (5.9)
	Max. tool diameter	mm(inch)	32 (1.2)
	Max. tool weight *1	kg(lbs)	0.4 (0.9)
Tool change time *4	Tool To Tool	sec.	3.0
	Chip To Chip	sec.	4.3
Electric motor	Main spindle motor (continuous) *2	kW	2.1
	Axis feed motor	kW	X, Y, Z axis: 0.32 A axis: 0.9
Power source	Power supply		AC 200 to 230 V±10%, 3-phase, 50/60Hz±2%
	Power capacity (continuous)	kVA	3.8
	Regular air pressure	MPa	0.4~0.6 (recommended value 0.5MPa *5)
	Required flow	L/min	20
Machine dimensions	Height	mm(inch)	2,033 (80.0)
	Required floor space [with control unit door open]	mm(inch)	998 x 1,656 [2,494] (39.3 x 65.2 [98.2])
	Weight	kg(lbs)	1,200 (2,646)
Standard accessories		Instruction Manual (DVD 1 set), leveling bolts (4 pcs.), leveling plate (4 pcs.), Chip tray, Top cover	

*1. Actual tool weight differs depending on the configuration and center of gravity. The figures shown here are for reference only. *2. Spindle motor output differs depending on the spindle speed. *3. Brother specifications apply to the pull studs. *4. Measured in compliance with JIS B6336-9 and MAS011-1987. *5. Regular air pressure varies depending on the machine specifications, machining program details, or use of peripheral equipment. Set the pressure higher than the recommend value. *6. Value when using high accuracy mode B and tool center point control.

NC unit specifications

CNC model	CNC-D00	Display	15-inch color LCD touch display	
Control axes	4 axes (X, Y, Z, A)	Memory capacity	500 Mbytes, 3 Gbytes (optional) (Total capacity of program and data bank)	
Simultaneously controlled axes	Positioning	4 axes (X, Y, Z, A)	External communication	
	Interpolation	Linear: 4 axes (X, Y, Z, A)		USB memory interface, Ethernet
		Circular: 2 axes		No. of registrable programs
Helical/Conical: 3 axes (X, Y, Z)	4,000 (Total capacity of program and data bank)			
Least input increment	0.0001 mm, 0.00001 inch, 0.0001 deg.	Program format	NC language	
Max. programmable dimension	±999999.9999 mm, ±99999.99999 inch	* "Control axes" and "Simultaneously controlled axes" indicate the maximum number of axes. * Ethernet is a registered trademark of Xerox Corporation in the United States.		

Option

- Teaching controller
- Jig base
- Rotary joint 6 ports
- Jig control valve unit (3-row)
- Side cover with transparent window
- Work light (1 or 2 lamps)
- Signal light (1, 2, or 3 lamps)
- Automatic door with switch panel (10 holes)
- Switch panel (10 holes)
- Tool breakage detector, touch type
- Spindle override
- Specified color
- Transformer box
- Memory expansion 3 Gbytes
- Interrupt type macro
- Rotary fixture offset
- EXIO board assembly
 - 1) EXIO board, input 32/output 32, additional #1
 - 2) EXIO board, input 32/output 32, additional #2
- Industrial network
 - 1) CC-Link, master station
 - 2) CC-Link, remote device station
 - 3) PROFIBUS DP, slave
 - 4) DeviceNet, slave
 - 5) PROFINET, slave
 - 6) EtherNet/IP, slave

● When exporting our machine, the machine is deemed to be included in the "applicable listed items" controlled by the Foreign Exchange and Foreign Trade Law of Japan. When exporting the machine, please obtain required permissions, including an export license, from the Ministry of Economy, Trade and Industry (METI) or Regional Bureaus of Economy, Trade and Industry before shipment. When re-selling or re-exporting the machine, you may need to obtain permissions from METI, and the government of the country where the machine is installed.

Brother Technology Center Chicago

BROTHER INTERNATIONAL CORP.
2200 North Stonington Avenue, Suite 270, Hoffman Estates, IL 60169, U.S.A.
PHONE:(1)224-653-8415 FAX:(1)224-653-8821

Brother Technology Center Frankfurt

BROTHER INTERNATIONALE INDUSTRIEMASCHINEN GmbH
Hoechster Str.94, 65835 Liederbach, Germany
PHONE:(49)69-977-6708-0 FAX:(49)69-977-6708-80

Brother Technology Center Bengaluru

BROTHER MACHINERY INDIA PVT LTD.
SB-111-112, 1st Stage, 2nd Cross, Peenya Indl Estate, Bengaluru - 560058 Karnataka, India
PHONE:(91)80-4705-3355

Brother Technology Center Shanghai

BROTHER MACHINERY SHANGHAI LTD.
Unit 01, 5/F., No.799, West Tianshan Rd., ChangNing District Shanghai 200335, China
PHONE:(86)21-2225-6666 FAX:(86)21-2225-6688

Brother Technology Center Chongqing

BROTHER MACHINERY SHANGHAI LTD.
Room 30, 31, NO.104 Cuibai Road, Dadukou District, Chongqing Province, 400084, China
PHONE:(86)23-6865-5600 FAX:(86)23-6865-5560

Brother Technology Center Nanjing

BROTHER MACHINERY SHANGHAI LTD.
Room 106, Building 02, Tian An Cyber Park, No.36, Yongfeng Avenue, Qinhuai District, Nanjing City, Jiangsu Province, China
PHONE:(86)25-87185503 FAX:(86)25-8718-5503

Brother Technology Center Queretaro

BROTHER INTERNATIONAL DE MÉXICO, S.A. DE C.V.
Calle 1 No.310 Int 15, Zona Industrial Jurica, Parque Industrial Jurica,
Queretaro, QRO C.P. 76100 México
PHONE:(52)55-8503-8760 FAX:(52)442-483-2667

Brother Technology Center Bangkok

BROTHER COMMERCIAL (THAILAND) LTD.
317 Pattanakarn Road, Pravet Sub-District, Pravet District, Bangkok 10250, Thailand
PHONE:(66)2321-5910 FAX:(66)2321-5913

Brother Technology Center Gurugram

BROTHER MACHINERY INDIA PVT LTD.
Plot No. 60, Sector 34, HSIIDC, Gurugram, Haryana 122001, India
PHONE:(91)0124-4449900

Brother Technology Center Dongguan

BROTHER MACHINERY SHANGHAI LTD.
Room 103, Building 1, No.2 Nanbo Road,
Songshan Lake District, Dongguan City, Guangdong Province, China
PHONE:(86)769-2238-1505 FAX:(86)769-2238-1506

Brother Technology Center Ningbo

BROTHER MACHINERY SHANGHAI LTD.
1F, Building 1, No. 102, Hongtang South Road West Section, Jiangbei District, Ningbo City,
Zhejiang Province, China
PHONE:(86)574-87781232 FAX:(86)574-88139792

Figures in brackets () are the country codes.

Specifications may be subject to change without any notice.

BROTHER INDUSTRIES, LTD.

Machinery Business Division

1-5, Kitajizoyama, Noda-cho, Kariya-shi, Aichi-ken 448-0803, Japan
<https://www.brother.co.jp>



Please check here for detailed information
and the latest information of the base.

<https://machinetool.global.brother/>

